

Fig. 4

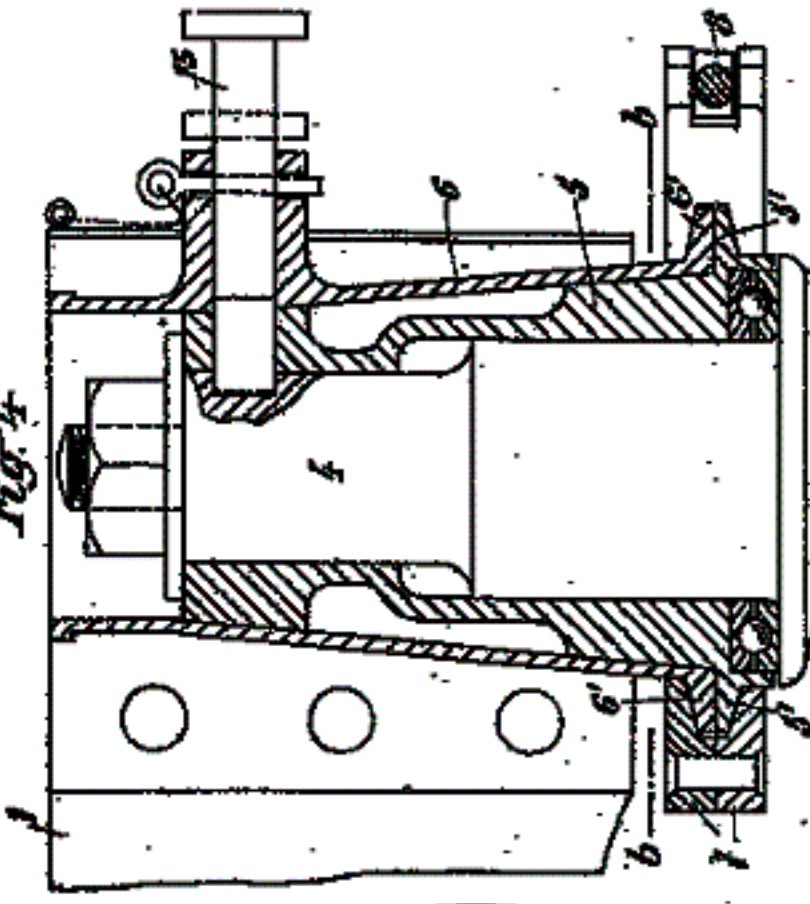

Fig. 1

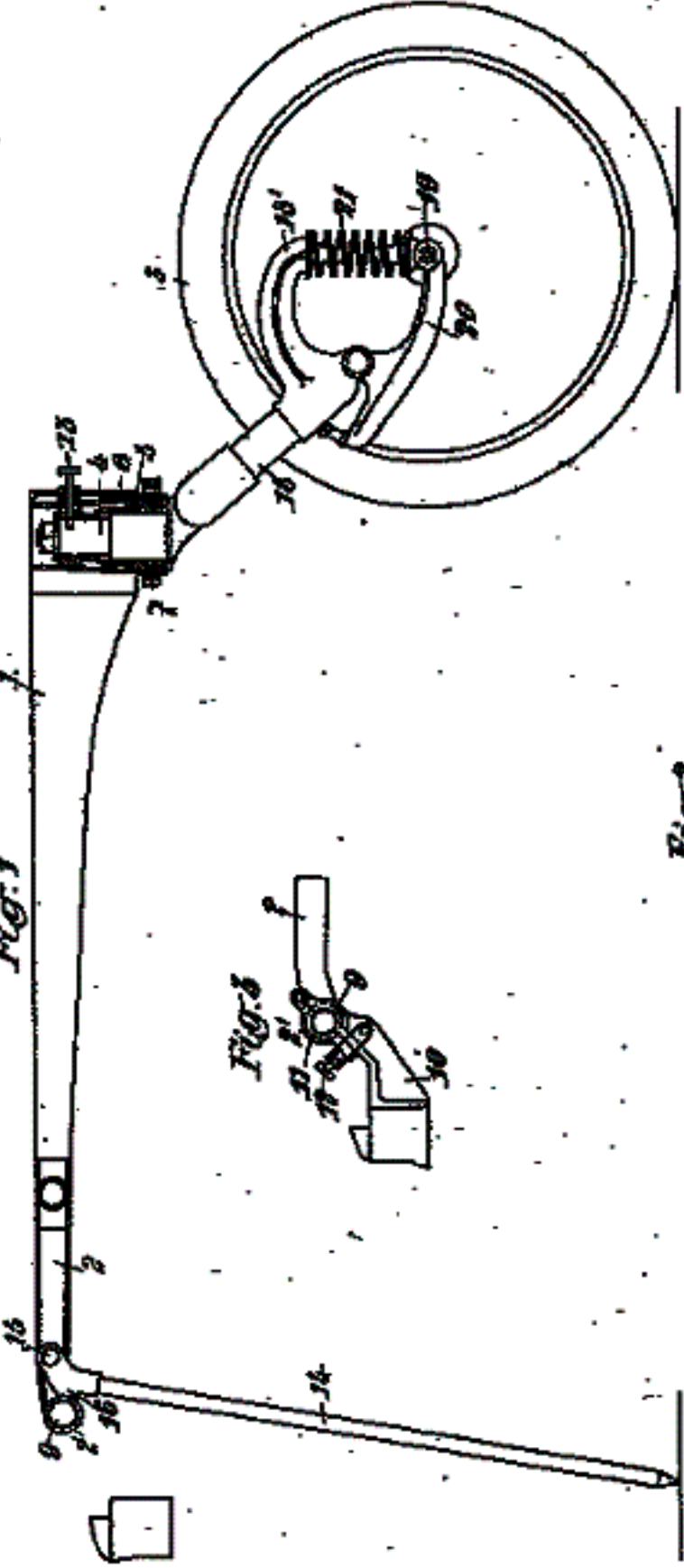

Fig. 3



Fig. 2

